

MCR5000 SERIES USER MANUAL

MCR5010

MCR5030

MCR5100

MCR5200

MATRIX TECHNOLOGY INC.

MCR METER Manual

Chapter 1 Instrument inspection and preparation -----	2
1.1 The crates -----	2
1.2 Power connection -----	3
1.3 Fuse and toggle switch -----	3
1.4 Environmental requirements -----	3
1.5 Test fixture requirements -----	3
1.6 Accuracy guarantee -----	4
Chapter 2 Introduction -----	4
2.1 Front panel description -----	4
2.2 Rear panel description -----	5
2.3 Basic operation -----	5
2.4 Data storage format -----	5
Chapter 3 Function description -----	6
3.1 <MEAS DISP> -----	6
3.2 < BIN DISP > (MCR5010 no this feature) -----	7
3.3 <MULTI PARA.DISP> (only MCR5200 has this function) -----	7
3.4 <MEAS SETUP> -----	8
3.5 <SYSTEM SETUP> -----	8
3.6<COMMSETUP> -----	8
3.7 <ABOUT> -----	9
3.8 <INTER Files List> , <EXT Files List> -----	9
Chapter 4 Performance -----	10
4.1 Range -----	10
4.2 Accuracy -----	11
Chapter 5 HANDLER interface -----	14
5.1 HANDLER interface introduction -----	14
Chapter 6 Operation example -----	16
6.1 Clear operation -----	16
6.2 Set sorting -----	17
Appendix: list of parameters of various models -----	18

Statement: in this paper, the content of the instrument. Our company have the right to the instrument performance, appearance, function, accessories, packing and so on to improve and improve without further instructions! The resulting manual do not agree with instruments of confusion, can contact us through the following ways.

Chapter 1 Instrument inspection and preparation

Please be sure to check the receipt of the instrument, and must understand and have the condition before using the instrument.

1.1 The crates

- After receiving the product, it is found that the packing is badly damaged. Please keep it until it is normal for the whole machine and the accessories.
- Check the machine, if the instrument is damaged, please contact the dealer or the company in charge of the business.
- Please check the attachment, please check the attachment according to the packing list, if the attachment is missing or damaged, please contact your dealer or division to protect your rights and interests.

1.2 Power connection

(1) Power supply voltage range:

100 ~ 120 Vac (The power supply of the instrument rear panel is selected as 110V display)

198 ~ 242 Vac (The power supply of the instrument rear panel is selected as 220V display)

(2) Frequency range of power supply: 47 ~ 63 Hz。

(3) Power supply range: ≥ 30 VA。

(4) Wire-L、Wire-N、Groud-E should be the same as the power plug of the instrument.

The instrument has been carefully designed to reduce the interference caused by the input of the AC power supply side, but still should try to make it in low noise environment, if you can not avoid, please install the power filter.

Warning: in order to prevent leakage of equipment or artificial damage, the user must ensure that the power supply to the earth ground reliable.

1.3 Fuse and toggle switch

Instrument factory has been equipped with a fuse, the user should use the company equipped with a fuse.

Warning: you should pay attention to the position of the toggle switch is consistent with the power supply voltage range of power on before.

1.4 Environmental requirements

- (1) Please do not use in the dust, vibration, direct sunlight, corrosive gases, such as the use of bad environment.
- (2) Instrument is not used for a long time, please put it in the original packing box or similar to the box in the reservoir is 5 to 40 DEG C temperature, relative humidity is not more than 85% RH of the indoor ventilation, air should not contain harmful impurity in corrosion measurement instrument and should avoid direct sunlight.
- (3) Please ensure that the instrument is in good ventilation condition, do not plug the instrument cooling and ventilation holes.
- (4) In particular, the instrument is connected with the test wire of the test piece to be far away from the strong electromagnetic field, so as not to interfere with the measurement.

1.5 Test fixture requirements

Please use the company's test fixture or test cable, the instrument test fixture or test cable should be kept clean, the test device pin to keep clean, to ensure that the test device and the fixture

is in good contact. The test fixture or test cable is connected to the HD, HS, LS and LD of the front panel of the instrument. The shield layer can be connected to the rear panel of the instrument, and the shield layer can be connected with the rear panel of the instrument.

User homemade or other company test fixtures or test cables may result in incorrect measurement results.

26004-1 Test fixture instructions

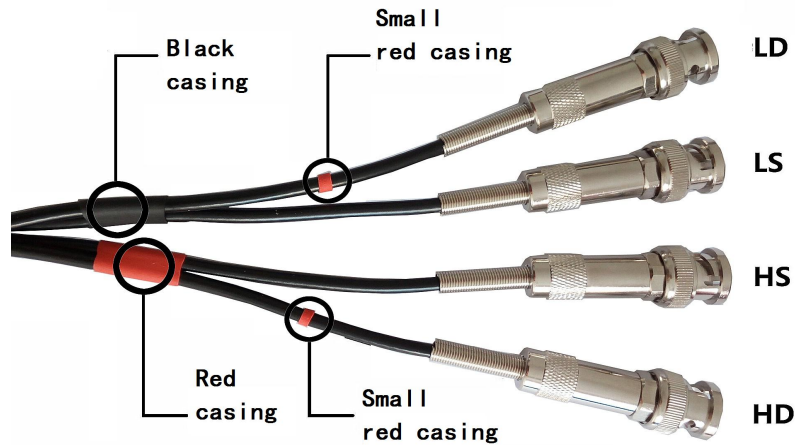

1.6 Accuracy guarantee

- (1) In order to ensure the accurate measurement of the instrument, the heating time should be no less than 15 minutes.
- (2) Do not frequent switching equipment, in order to avoid confusion caused by internal data.
- (3) Correct open circuit and short circuit operation.

Chapter 2 Introduction

A new generation of high precision and high stability of boutique MCR meter is MCR5010, MCR5100, MCR5200, the 4.3 inch 480*272 TFT display screen, display classical and intuitionistic.

The series of equipment is highly applicable to the majority of manufacturers production inspection. And the series of equipment has a variety of output impedance model can be used for different manufacturers needs, its superior performance can be achieved business standards and military standards of a variety of tests (such as IEC and MIL).

2.1 Front panel description

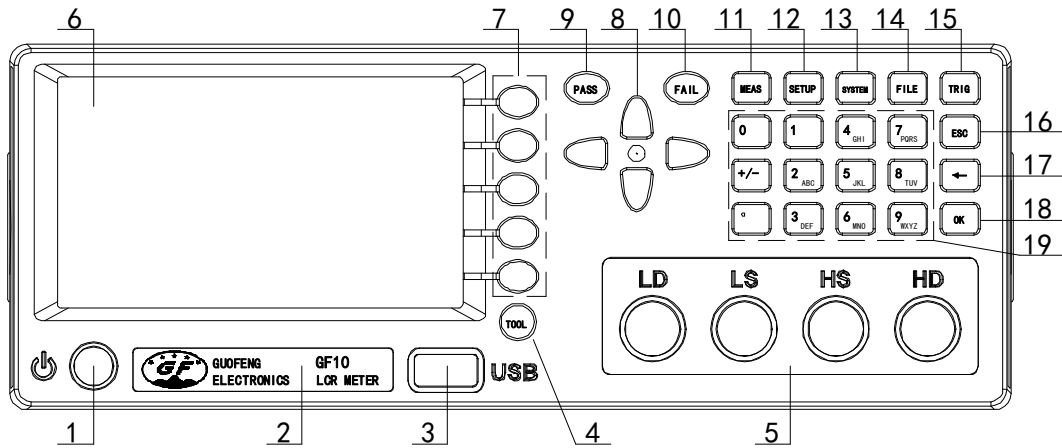

- 1. Power switch
- 2. Instrument type label
- 3. USB interface
- 4. Tool key
- 5. Test terminal: LD、LS、HS、HD
- 6. 4.3 inch TFT LCD screen
- 7. Soft-key
- 8. Direction key
- 9. PASS light, Qualified judgment lamp
- 10. FAIL light, Failure product judgment lamp
- 11. MEAS, Measurement display page shortcut key
- 12. SETUP, Measurement set page shortcut key
- 13. SYSTEM, System settings page shortcut keys
- 14. FILE, File management page shortcuts
- 15. TRIG, Trigger measure key
- 16. ESC, Cancel key
- 17. ←, Backspace key, used to delete the previous input
- 18. OK, Confirm input key
- 19. Alphanumeric keypad symbols

2.2 Rear panel description

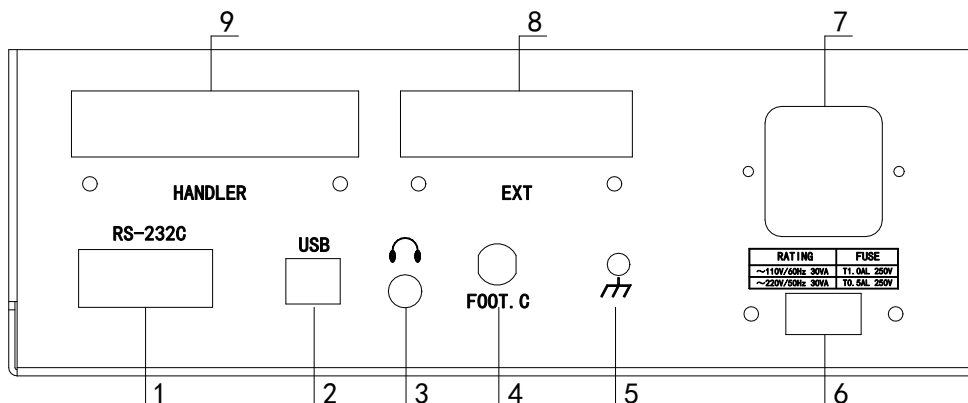

- 1. RS232C, serial port
- 2. USB DEVICE
- 3. Earphone port
- 4. FOOT.C, Foot switch interface
- 5. Ground
- 6. Power switch (110V/220V)
- 7. Power supply socket
- 8. Extended interface
- 9. HANDLER, Sorting interface

2.3 Basic operation

1. Direction key: used to move the cursor.
2. Soft keys, used to change the parameters set of features.
3. Shortcut menu: MEAS, SETUP, SYSTEM, FILE, press directly into the < MEAS DISP >, < MEAS SETUP >, < SYSTEM SETUP >, < INTER/EXT Files List> function page settings.

Reminder: when in < MEAS DISP > page, and the cursor in < MEAS DISP >, press MEAS key, < MEAS DISP > page test results will be full screen display.

4. TOOL: Tool key, In each function page tool will be different.

When the short press TOOL key, key area will be a corresponding tool operation, short press TOOL key again, the tools menu disappear.

When long press tool button for one second, the instrument into the key lock state, pressing other keys invalid; again the press tool button for one second instrument will remove key lock state.

2.4 Data storage format

USB storage, use the TOOL key in the measurement of the page, there will be data storage function. The basic form is as follows:

<A>, [, <COMP>]

A, B is the first & second parameter measurement results, scientific counting method to save.

<COMP> is the sorting result, MCR5010 has no sorting function.

COMP	Explain
0	OUT
1	BIN 1
2	BIN 2
3	BIN 3
4	AUX
5	No comparison

Chapter 3 Function description

3.1 <MEAS DISP>

The page can be set as follows:

MEAS DISP softkey : press this key into <MEAS DISP> page.

BIN DISP softkey : press this key into <BIN DISP> page.(MCR5010 no such function)

MULTI PARA. Softkey: press this key into <MULTI PARA. DISP> page.(only MCR5200 has this function)

Quick Clear : press this key to SHORT & OPEN all frequency points.

FUNC: MCR5010/MCR5030/MCR5100/MCR5200 can set parameters:

Cs-D, Cp-D, Ls-Q, Lp-Q, Rs-Q, Rs-D, Rp-Q, Rp-D, R-X, Zs-θ, Zs-r;

Parameter implication:

Cs: Capacitance (series equivalent mode)

Cp: Capacitance (parallel equivalent mode)

Ls: Inductance (series equivalent mode)

Lp: Inductance (parallel equivalent mode)

Rs: Series equivalent resistance(ESR))

Rp: Parallel equivalent resistance(EPR)

D : loss

Q : quality factor

R : resistance

X : reactance

Zs: Series equivalent impedance

θ : angle

r : angle

RANGE: AUTO, HOLD, INCR +, DECR -

FREQ: Set frequency

MCR5010 : 100Hz, 120Hz, 1kHz, 10kHz,

MCR5030: 100Hz,120Hz,1kHz,10kHz, 20kHz, 30kHz

MCR5100: 40Hz、50Hz、60Hz、80Hz、100Hz、120Hz、150Hz、200Hz、250Hz、300Hz、400Hz、500Hz、600Hz、800Hz、1kHz、1.2kHz、1.5kHz、2kHz、2.5kHz、3kHz、4kHz、5kHz、6kHz、7.5kHz、10kHz、12kHz、15kHz、20kHz、25kHz、30kHz、40kHz、50kHz、60kHz、75kHz、100kHz

MCR5200: 40Hz、50Hz、60Hz、80Hz、100Hz、120Hz、150Hz、200Hz、250Hz、300Hz、400Hz、500Hz、600Hz、800Hz、1kHz、1.2kHz、1.5kHz、2kHz、2.5kHz、3kHz、4kHz、5kHz、6kHz、7.5kHz、10kHz、12kHz、15kHz、20kHz、25kHz、30kHz、40kHz、50kHz、60kHz、75kHz、100kHz、120kHz、150kHz、200kHz

SPEED : FAST、MED、SLOW

LEVEL : 1V, 0.3V, 0.1V

COMP : ON , Open the comparison function
OFF, Close comparison function

BIN DISP,press this key into <BIN DISP> page

Test result display area:

FONT SMALL/LARGE,press this key to change the font size.

DISP ON/OFF,press this key to open or close test results display

DEV OFF/ABS/% :

the deviation function only for the main parameters, there are 3 ways:OFF、ABS、%
(MCR5010 no this feature)

OFF: Normal display mode

ABS: Absolute deviation display mode

The absolute deviation of the measured value of the current component minus the preset nominal value. The absolute deviation of the calculation formula is as follows:

$$\Delta\text{ABS} = X - Y$$

Among them, X is the measured value of the current measured, Y is set to the nominal value.

%: Percentage deviation display mode

The percentage deviation is the percentage of the nominal value of the measured value of the current component and the difference between the predetermined nominal value. The calculation formula of the percentage deviation is as follows:

$$\Delta\% = (X - Y) / Y \times 100[\%]$$

Among them, X is the measured value of the current measurement, Y for the set of the nominal value.

Vm ON/OFF : Open or close voltage monitoring function

Im ON/OFF : Open or close current monitoring function

3.2 < BIN DISP > (MCR5010 no this feature)

This page can be set as follows:

COMP ON/OFF : to open or close the comparison function

AUX ON/OFF : to open or close AUX.

AUX is the main parameter is qualified, and the Deputy parameter is not qualified.

COUT ON/OFF : to open or close the counting function

NOMINAL : By using digital key and softkey input. (the reference value for the comparison of the main parameters)

MODE $\Delta\%$ / ABS : to choice the comparison mode.

$\Delta\%$:Relative percentage mode

ABS :Absolute value comparison mode

LOW and HIGH :Through digital key, the OK key and the softkey input.

Test result display area: DISP ON/OFF;DEV OFF/ABS/%(Same as in 3.1)

3.3 <MULTI PARA.DISP> (only MCR5200 has this function)

This page can be set as follows:

FREQ : Set frequency

LEVEL: Set test voltage

1/2/3/4/5 test parameter: The test parameters required by soft region selection.

3.4 <MEAS SETUP>

This page can be set as follows:

ResSource : 30 Ω /100 Ω ,Select output resistance mode

AVERAGE : 1~255.By using digital key input or softkey "INCR+" and "DECR -".

RangeDwell : Range delay. 0~6000ms.By using digital key input or softkey "INCR+" and "DECR -".

TrigSource : INT,EXT.(Trigger mode)

TrigDelay : 0~6000ms.By using digital key input or softkey "INCR+" and "DECR -".

TrigEdge : RISING,FALLING .The rising edge of the trigger; the falling edge of the trigger

Handler : CLEAR,HOLD,PULSE. Sorting signal mode

PulseWidth : 1~9999ms.(pulse width)

3.5 <SYSTEM SETUP>

This page can be set as follows:

Theme : TRAD-BLUE,TRAD BLACK,BLACKISH GREEN.(Display style)

Language : English、中文 .(Language environment)

Key Tone : ON,OFF. Open or close button sound

ToneSour : MASTER,EARPHONE,ALL.(Buzzer mode,EARPHONE socket is optional)

PassTone : OFF,LONG,SHORT,TWO SHORT

FailTone : OFF,LONG,SHORT,TWO SHORT

ParaSave : AUTO SAVE,AUTO LOAD,NO SAVE

MCR METER Manual

- AUTO SAVE : This feature will save the settings of the measurement parameters in real time, the next boot state will be the same as the last shutdown.
- AUTO LOAD : Automatically invokes the last loaded internal file.
- NO SAVE : Each boot display parameters for the default configuration of the instrument.

PassWord : OFF,LOCK SYSTEM,LOCK FILE,MODIFY,SAVE TO U_DISK

- OFF : No password
- LOCK SYSTEM : File and boot need password to perform the operation
- LOCK FILE : File requires a password to perform the operation
- MODIFY : Modify password.

Factory default password : 0010(MCR5010)

0100(MCR5100)

0200(MCR5200)

- SAVE TO U_DISK : Save the password to U disk.For example, the password file named "0010.STA" (determined by the instrument model).When the instrument operation need to enter a password, can advance with password U disk plug the USB interface of the instrument, instrument will automatically detect the password file is valid, so as to achieve the purpose of lifting passwords.

3.6 <COMM SETUP>

This page can be set as follows:

Bus Mode : RS232C,GPIB,USBTMC,USBCDC

BaudRate : INCR+,DECR- (4800,9600,19200,38400,115200)

Data Bit : 6,7,8

Stop Bit : 1,2

Parity : None,Odd,Even

Tx Term : LF 0x0A,CR 0x0D,LFCR

GpibAddr : In the 0~31 value through the softkey or the number keys set.

3.7 <ABOUT>

Press [ABOUT SYSTEM] softkey into <ABOUT> page.

This page display instrument ID number and other registered information.

Soft key functions are as follows:

- Reset: press it to restart this instrument.
- Factory: Instrument returned to the factory status. Need to enter a password to confirm.
- Update: Push button upgrade system. Need to insert the U disk with the upgrade file
- EXIT: Return to < SYSTEM SETUP> page.

3.8 <INTER Files List> , <EXT Files List>

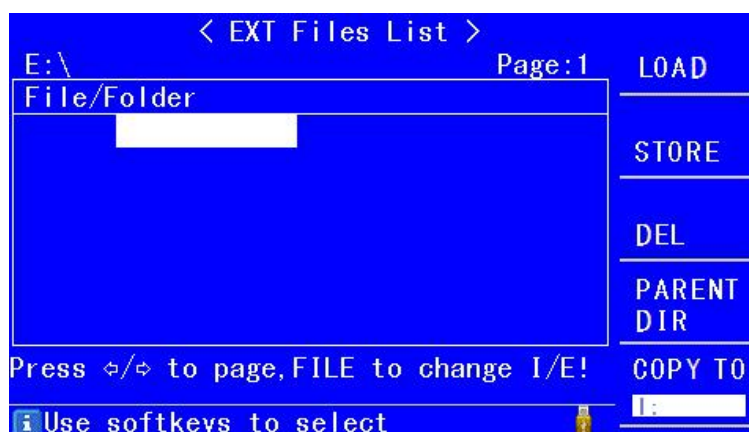
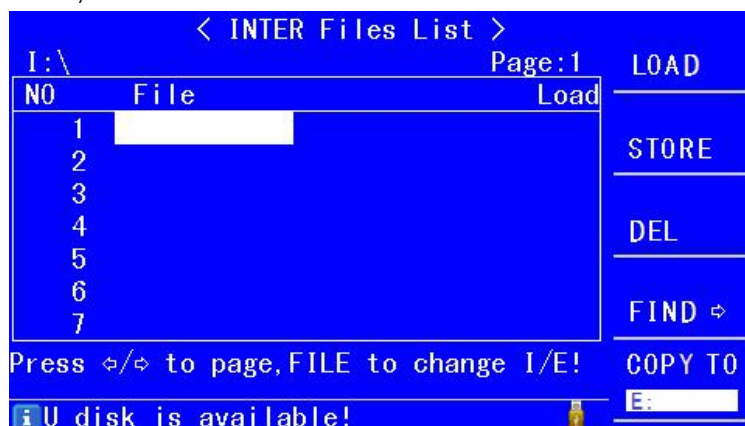

The parameters set by the user in form of a file stored in the instrument internal non-volatile memory, when the next time you want to use the same settings, users do not need to set these parameters, only need to load the appropriate file, the last set of parameters are obtained. Thus greatly saving the time for the user to re set the parameters and improving the production efficiency.

Press FILE button to enter the < INTER Files List > page. Press the FILE key again to switch the internal / external file.

Operation procedure description:

- A. Review existing files
 - 1) By using the upper and lower keys, one by one look.
 - 2) Use the left and right buttons, can look at the page.
 - 3) Input file number keys corresponding to the serial number, then press the button [OK], can be directly read the required file.
- B. Follow these steps to save the parameter to the file.
 - 1) The number at the cursor to need to save the file, press [STORE] softkey;
 - 2) Select softkey [YES] into the next step, select the key [NO] cancel the save operation;
 - 3) If step 2) select [YES], use the numeric keys to enter the file name and press [OK] to confirm. If the serial number is already in the file, you can override the file or cancel the operation according to the screen.
- C. Follow these steps to load the parameters set in the corresponding file.
 - 1) Press the FILE key to switch to the file management page.
 - 2) Move the cursor to the file location in the file list, or direct input file serial number.
 - 3) Press LOAD key.
 - 4) Select softkey YES, loading the current file, and return to the current page.

- D. Follow the steps for copying files to E (U disk).
- 1) Insert the U disk into the instrument front panel USB interface.
 - 2) Move the cursor to the file, press the soft key "copy to E:"
 - 3) According to the screen, press the soft key "YES" to copy.
 - 4) If U disk file with the same file name, screen prompt the need to cover, according to the soft key "YES" to continue copying, press the soft key "NO", cancel the copy.

Chapter 4 Performance

Specific reference to each model parameter table in the appendix.

The following is part of the parameter description:

4.1 Range

In 100 ohm source resistance, using a total of 5 range: 31.6Ω, 100Ω, 1kΩ, 10kΩ,100kΩ

In 30 ohm source resistance, using a total of 6 range : 10Ω, 30Ω, 100Ω, 1 kΩ, 10 kΩ,100 kΩ

The effective measurement range of each range is shown in the

following table.

Table 4-1 The range in 100Ω source resistance

No.	Range Resistance	Effective measurement range
0	100 kΩ	100kΩ-100MΩ
1	10 kΩ	10kΩ-100kΩ
2	1 kΩ	1kΩ-10kΩ
3	100Ω	50Ω-1kΩ
4	30Ω	0Ω-50Ω

Table 4-2 The range in 30Ω source resistance

No.	Range Resistance	Effective measurement range
0	100 kΩ	100kΩ-100MΩ
1	10 kΩ	10kΩ-100kΩ
2	1 kΩ	1kΩ-10kΩ
3	100Ω	100Ω-1kΩ
4	30Ω	15Ω-100Ω
5	10Ω	0Ω-15Ω

4.2 Accuracy

The accuracy of $|Z|$, L, C, R, X

The accuracy of A_e about $|Z|$, L, C, R, X is expressed by the following formula:

$$A_e = \pm[A + (K_a + K_b + K_f) \times 100 + K_c] \times K_c \quad [\%]$$

A: Basic measurement accuracy (See Figure 4-1)

K_a : Impedance scaling factor (See table 4-4), when using the impedance is less than 500 ohm .

K_b : Impedance scaling factor (See table 4-4), when using the impedance is greater than 500 ohm.

K_c : Temperature factor (See table 4-5)

K_f : Calibrated interpolation factor (See table 4-6)

K_L : Cable length factor (See table 4-7)

ⓘ Be careful: According to the impedance size, it is only one valid about K_b and K_a , and the other one is replaced by 0.

L, C, X accuracy conditions: D_x (Measured value of D) ≤ 0.1

R accuracy conditions: Q_x (Measured value of Q) ≤ 0.1

When $D_x \geq 0.1$, A_e of L, C, X: $A_e = A_e * \sqrt{1 + D_x^2}$

When $Q_x \geq 0.1$, A_e of R: $A_e = A_e * \sqrt{1 + Q_x^2}$

Accuracy of D

The accuracy of D_e about D is expressed by the following formula:

$$D_e = \pm \frac{A_e}{100}$$

When $D_x \leq 0.1$, $D_e = D_e$

When $D_x > 0.1$, $D_e = D_e * (1 + D_x)$

Accuracy of **Q**

The accuracy of Q_e about Q is expressed by the following formula:

$$Q_e = \pm \frac{Q_x \times D_e}{1 \mp Q_x \times D_e}$$

Here, Q_x is the test value of Q.

D_e is the accuracy of D

It is effective, when $Q_x \times D_e < 1$

Accuracy of **θ**

The accuracy of θ is expressed by the following formula:

$$\theta_e = \frac{180}{\pi} \times \frac{A_e}{100} \quad [\text{deg}]$$

Accuracy of **R_p**

When $D_x \leq 0.1$, the accuracy of R_p is expressed by the following formula:

$$R_p = \pm \frac{R_{px} \times D_e}{D_x \mp D_e} \quad [\Omega]$$

Here, R_{px} is the test value of R_p . [Ω]

D_x is the test value of D.

D_e is the accuracy of D

Accuracy of **R_s**

When $D_x \leq 0.1$, the accuracy of R_s is expressed by the following formula:

$$R_{se} = X_x \times D_e \quad [\Omega]$$

$$X_x = 2\pi f L_x = \frac{1}{2\pi f C_x}$$

Here, X_x is the test value of X. [S]

C_x is the test value of C. [F]

L_x is the test value of L. [H]

D_e is the accuracy of D, f is the test frequency.

Accuracy factor

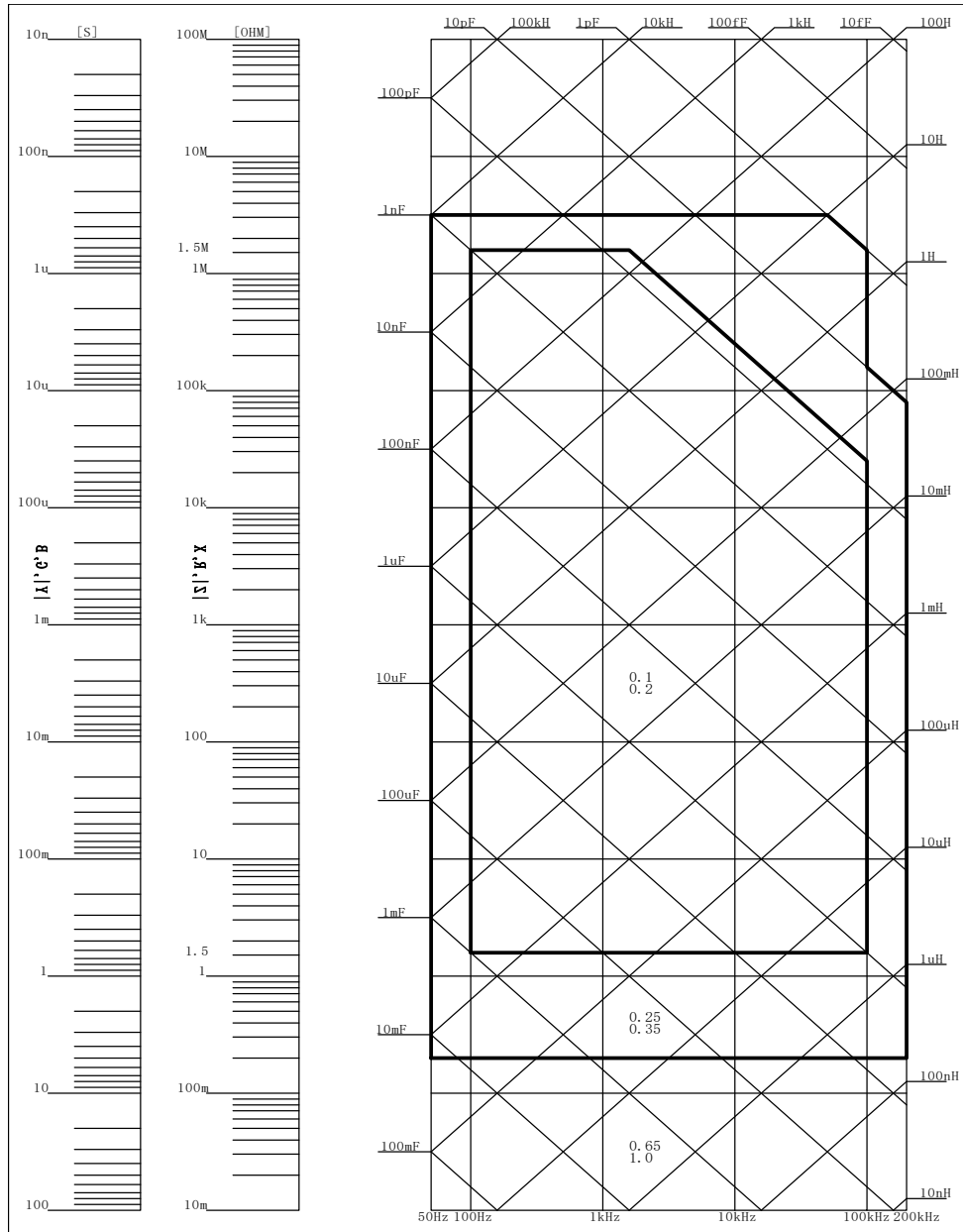

Figure 4-1 Basic measurement accuracy: A

Figure 4-1, in the junction line, can choose a smaller value. Figure 4-1, the value of the basic accuracy A selection method

is as follows:

0.1 (Smaller value) is the value of A ,when $V_s=1V$ and the test speed is MED or SLOW .

0.2 (Larger value) is the value of A ,when $V_s=1V$ and the test speed is FAST .

Test level correction factor: ArB (See table 4-3) , According to Figure 4-1 select the basic accuracy A, A multiplied by Ar to get the level correction of the basic measurement accuracy. Here, V_s is the test signal voltage.

Test signal voltage: V_s	Accuracy correction factor: Ar
0.1V	2.5
0.3V	1.5
1V	1

Table 4-3 Basic accuracy level correction factor

MCR METER Manual

Table 4-4 Impedance scaling factor : K_a 、 K_b

speed	frequency	K_a ($Z_m < 500\Omega$)	K_b ($Z_m > 500\Omega$)
MED, SLOW	$f_m < 100\text{Hz}$	$(\frac{1 \times 10^{-3}}{ Z_m })(1 + \frac{200}{V_s})(1 + \sqrt{\frac{100}{f_m}})$	$ Z_m (1 \times 10^{-9})(1 + \frac{70}{V_s})(1 + \sqrt{\frac{100}{f_m}})$
	$100\text{Hz} \leq f_m \leq 100\text{kHz}$	$(\frac{1 \times 10^{-3}}{ Z_m })(1 + \frac{200}{V_s})$	$ Z_m (1 \times 10^{-9})(1 + \frac{70}{V_s})$
	$f_m > 100\text{kHz}$	$(\frac{1 \times 10^{-3}}{ Z_m })(2 + \frac{200}{V_s})$	$ Z_m (3 \times 10^{-9})(1 + \frac{70}{V_s})$
FAST	$f_m < 100\text{Hz}$	$(\frac{2.5 \times 10^{-3}}{ Z_m })(1 + \frac{400}{V_s})(1 + \sqrt{\frac{100}{f_m}})$	$ Z_m (2 \times 10^{-9})(1 + \frac{100}{V_s})(1 + \sqrt{\frac{100}{f_m}})$
	$100\text{Hz} \leq f_m \leq 100\text{kHz}$	$(\frac{2.5 \times 10^{-3}}{ Z_m })(1 + \frac{400}{V_s})$	$ Z_m (2 \times 10^{-9})(1 + \frac{100}{V_s})$
	$f_m > 100\text{kHz}$	$(\frac{2.5 \times 10^{-3}}{ Z_m })(2 + \frac{400}{V_s})$	$ Z_m (6 \times 10^{-9})(1 + \frac{100}{V_s})$

Here, f_m : Test frequency . [Hz]

Z_m : Measured impedance. [Ω]

V_s : Test signal voltage .[mV_{rms}]

Table 4-5 Temperature factor: K_c

Temperature (°C)	5	8	18	28		
			38			
K_c	6	4	2	1	2	4

Table 4-6 Calibrated interpolation factor : K_f

Test frequency	K_f
Typical frequency (Direct calibration)	0
Atypical frequency (Interpolation calibration)	0.0003

Note:At present, all types of frequency point is the typical frequency.

Table 4-7 Cable length factor

Test signal level	Cable length		
	0m	1m	2m
0.1V _{rms} ,0.3V _{rms}	0	$2.5 \times 10^{-4}(1 + 0.05f_m)$	$5 \times 10^{-4}(1 + 0.05f_m)$
1V _{rms}	0	$2.5 \times 10^{-3}(1 + 0.016f_m)$	$5 \times 10^{-3}(1 + 0.05f_m)$

Here, f_m is the test signal frequency. [kHz]

Chapter 5 HANDLER interface

5.1 HANDLER interface introduction

The interface is used to output the sorting result to the industrial control machine, so as to realize the automatic sorting test.

Table 5-1 Pin definition table for Handler interface

Pin number	Signal name	Described
1	/P1	Sorting result output.
2	/P2	All signal with pull up resistor collector output. Up pull supply can choose the internal +5V power supply, or external power supply EXTV (factory default). The internal pull resistor is 4.7kΩ.
3	/P3	
10	/NG	
11	/AUX	
12,13	/EXT.TRIG	The rising edge of this signal triggers the instrument to measure. The pulse width is more than 1μs, the low level of a driving current is about 5-10mA.
16,17,18	+5V	Internal +5V power output: Users generally do not recommend the use of internal power supply equipment, if you have to use, please ensure that the use of the current is less than 0.3A, and the signal line away from the source of interference.
27,28	EXTV	An external DC power supply for sorting interface signals is accessed from here. If you want to use the internal +5V power supply, need to change the jumper settings.
30	/IDX	/IDX valid after A/D conversion. When the signal is valid, the automatic test machine is allowed to move the next element to the position where it is to be measured. However, the current measurement results have to wait until /EOM is valid, then it is output.
31	/EOM	End Of Measurement: When the measured data and the comparison results are valid, the signal is valid.
34,35,36	COM	Reference to external power EXTV. When the Handler interface output signal using the internal power supply, the instrument's internal GND will be connected with the COM.

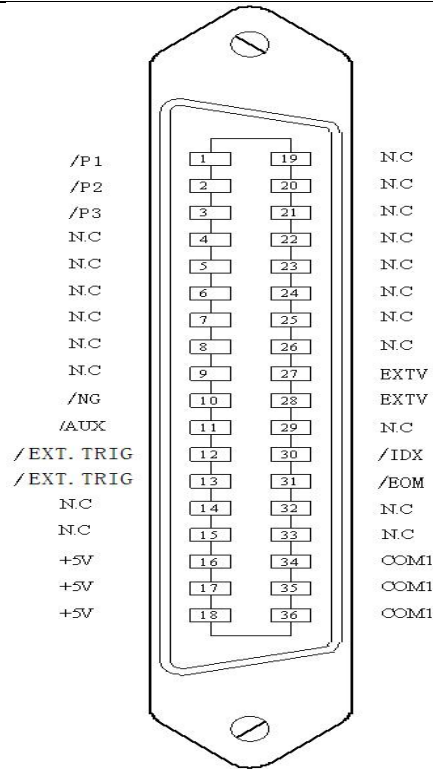

Figure 5-1 Handler interface pin definition

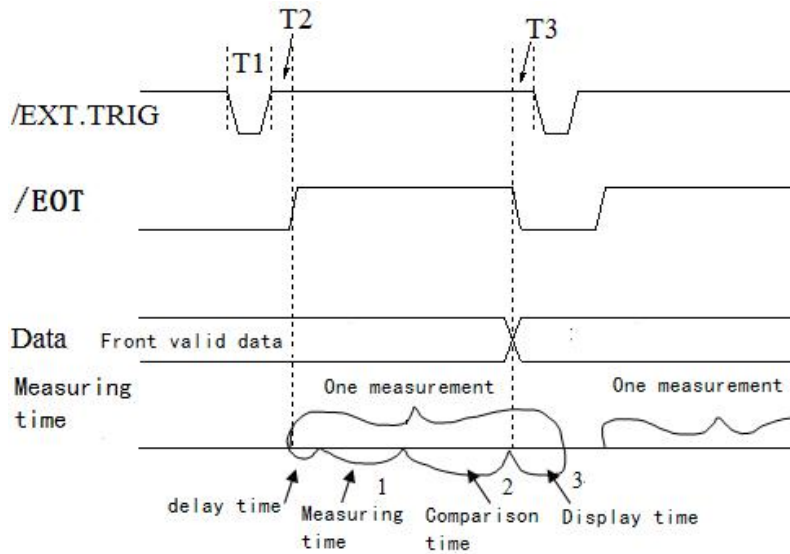

Figure 5-2 Timing diagram of interface signal

Description:

Time	Minimum value	Maximum value
T1 : Trigger pulse width	1us	Display time + 200us ---
T2 : Measurement start delay time	200us	
T3 :Trigger wait time after /EOT output	0us	

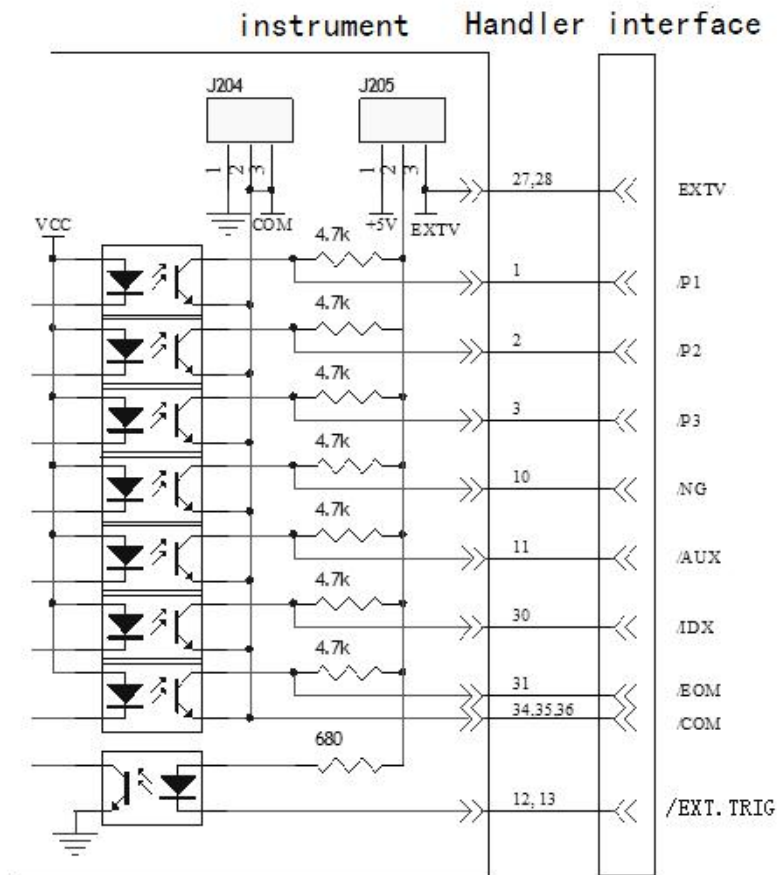

Figure 5-3 Schematic diagram of Handler interface signal

- When the internal power supply is used, the 1 and 2 of the J205 are connected; the 1 and the 2 of the J204 are connected.
- When using an external power supply (factory default), the 2 and 3 of the J205 are connected; the 2 and 3 of the J204 are connected.

Chapter 6 Operation example

6.1 Clear operation

One way to clear: (In this way, the instrument will clear all the frequency points)

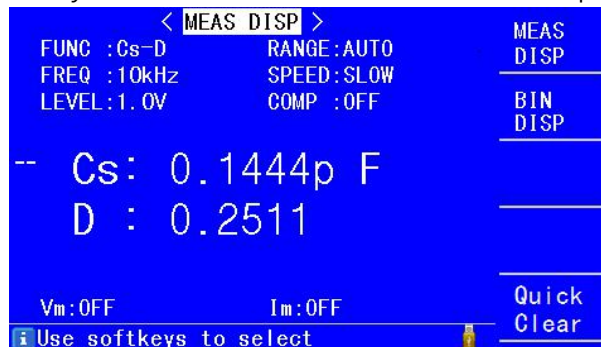

Figure 6-1 Measurement display page

Step:

1. As shown above, when the cursor is in <MEAS DISP>, the [Quick Clear] soft key will be displayed.
2. Press [Quick Clear] soft key, "To make UNKNOWN short" will be displayed on the screen. At this time, there are 3 regional soft options: [YES], [NO], [CANCEL].
3. Select [CANCEL], then quit the operation of SHORT; Select "NO", skip the SHORT operation, and enter the fourth step;

MCR METER Manual

Select "YES", the instrument will enter a short circuit cleared process, if the short circuit failure, will jump to the second step to re ask; **Note:** When performing SHORT operation, must ensure that the test fixture is short.

4. "To make UNKNOWN open" is displayed on the screen. At this time, there are 3 regional soft options: [YES], [NO], [CANCEL].
5. Select [CANCEL], then quit the operation of OPEN; Select "NO", skip the OPEN operation, and enter the sixth step; Select "YES", the instrument will enter a open circuit cleared process, if the open circuit failure, will jump to the second step to re ask; **Note:** When performing OPEN operation, must ensure that the test fixture is open.
6. Clear end.

Another way to clear: (In this way, the instrument will clear current frequency point)



Figure 6-2

1. Press [TOOL] key in <MEAS DISP> page or in <BIN DISP> page ,or in <MULTI PARA. DISP> page, the [SINGLE SHORT] and [SINGLE OPEN] will displayed .
2. If you need SHORT operation, please make the test fixture short, and then select the [SINGLE SHORT] softkey, the current test status will be short circuit cleared.
3. If you need OPEN operation, please make the test fixture open, and then select the [SINGLE OPEN] softkey, the current test status will be open circuit cleared.

6.2 Set sorting



Figure 6-2 <BIN DISP> page

1. Press the "MEAS" button on the panel to enter the < MEAS DISP > page (as shown in Figure 6-1), and press "BIN DISP " softkey to enter < BIN DISP > page (as shown in Figure 6-2).
2. Move the cursor to the "NOMINAL", press the number keys and softkey to input the nominal value of main parameter.
3. Move the cursor to the lower or upper limit of the BIN1~ BIN3, use digital keys and OK key to enter the upper and lower limits.
4. Move the cursor to the lower or upper limit of 2nd , press the number keys and softkey to input the upper and lower limits of the second parameter.

MCR METER Manual I

5. Move the cursor to "COMP", open the comparison switch.

Appendix: list of parameters of various models

Measurement function	
MCR test parameters	Z , Y , C, L, X, B, R, G, D, Q, θ
Test frequency	MCR5010 : 100Hz,120Hz,1kHz,10kHz
	MCR5030 : 100Hz,120Hz,1kHz,10kHz, 20kHz, 30kHz
	MCR5100 : 40Hz、50Hz、60Hz、80Hz、100Hz、120Hz、150Hz、200Hz、250Hz、300Hz、400Hz、500Hz、600Hz、800Hz、1kHz、1.2kHz、1.5kHz、2kHz、2.5kHz、3kHz、4kHz、5kHz、6kHz、7.5kHz、10kHz、12kHz、15kHz、20kHz、25kHz、30kHz、40kHz、50kHz、60kHz、75kHz、100kHz
	MCR5200 : 40Hz、50Hz、60Hz、80Hz、100Hz、120Hz、150Hz、200Hz、250Hz、300Hz、400Hz、500Hz、600Hz、800Hz、1kHz、1.2kHz、1.5kHz、2kHz、2.5kHz、3kHz、4kHz、5kHz、6kHz、7.5kHz、10kHz、12kHz、15kHz、20kHz、25kHz、30kHz、40kHz、50kHz、60kHz、75kHz、100kHz、120kHz、150kHz、200kHz
Basic measurement accuracy	0.1% (MCR5010:0.15%)
equivalent circuit	In series, parallel
Mathematics function	Absolute deviation, Percentage deviation
Range mode	AUTO, HOLD, Manual selection
Trigger mode	INT, EXT
Speed (≥ 1 kHz)	FAST: less than 30 times per second, MED : 10 times per second, SLOW: 3 times per second,
Average number	1—255
Delay Time	0—6s, 1ms step
Calibration function	Quick Clear / SINGLE SHORT /SINGLE OPEN
Test terminal	Five terminals
Display mode	Direct display, Δ , $\Delta\%$, V/I
Monitor	5 bit resolution, 4.3 inch LCD display
test signal	
Output impedance	30 Ω ,100 Ω
Test signal level	0.1V、0.3V、1V ; Accuracy: 5%
Display range	
Z , R, X	0.01m Ω — 99.999 M Ω
Y , G, B	0.0001 μ S — 99.999 S
C	0.0001 pF — 9.9999 F
L	0.0001 μ H — 999.99 H
D	0.0001 — 9.9999
Q	0.0001 — 99999
θ (DEG)	-179.99 $^\circ$ — 179.99 $^\circ$
θ (RAD)	-3.14159 — 3.14159
Other	
Multi parameter display	Five parameters can be selected to test and display at the same time about MCR5200

MCR METER Manual

Comparator function	Five BIN sorting function (BIN1,BIN2,BIN3,AUX,OUT)
storage	Internal: 105; external can save 500
Interface	Standard:RS232C,USB HOST,HANDLER (Except MCR5010) 、 Optional:USB DEVICE, headphone jack, Foot switch interface ,GPIB